

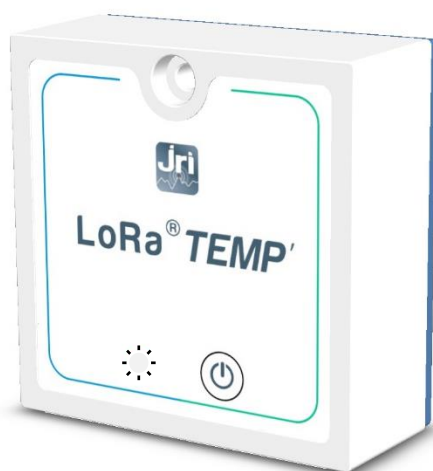

LoRa® TEMP'

USER GUIDE



Ref : 12628

TABLE OF CONTENTS

I.	INTRODUCTION	3
a)	Box contents	3
b)	Symbols.....	3
II.	INSTALLATION RECOMMANDATIONS	4
a)	Sources of disturbances or attenuation	4
b)	Positioning	4
III.	PRESENTATION	5
a)	Case.....	5
b)	Mounting	5
IV.	USE	6
a)	Device activation	6
b)	Turning off the device.....	6
c)	LED functionality.....	6
V.	BATTERY REPLACEMENT	7
a)	Removal of the battery.....	7
b)	Installation of the new battery	7
VI.	CHARACRERISTICS	8
a)	Compliance	8
VII.	CLEANING	9
VIII.	GUARANTEE	9
IX.	MAINTENANCE CONTRACT	9
X.	ENVIRONMENTAL PROTECTION	10

I. INTRODUCTION

The LoRa® TEMP' is a temperature indicator measuring temperature and transmitting data wirelessly to a web platform using the LoRa® long-distance network.





The LoRa® TEMP' complies with the ISO EN 13485 standard



a) Box contents

- ▶ 1 LoRa® TEMP'
- ▶ 1 battery
- ▶ 1 wall mounting device
- ▶ 1 user guide

b) Symbols

	RECYCLING: electrical items should be disposed of separately from household waste. For more information on collection, re-use and recycling schemes, contact your local waste service authorities.
	Power source: the LoRa TEMP is powered by a type A lithium battery (§ ch. V).
	CE LABELING: this device is certified to comply with European regulations for electrical safety, flammability, disruptive electromagnetic emissions, and immunity to environmental electrical disturbances.
	Redirect to JRI MySirius home page
	<p>FCC ID: W4512267</p> <p><i>This device complies with Part 15 of the FCC Rules. Operation is subject to the following two conditions: (1) this device may not cause harmful interference, and (2) this device must accept any interference received, including interference that may cause undesired operation</i></p> <p><i>In accordance with FCC requirements, changes or modifications not expressly approved by JRI could void the user's authority to operate this product.</i></p> <p>NOTE: <i>This equipment has been tested and found to comply with the limits for a Class A digital device, pursuant to Part 15 of the FCC Rules. These limits are designed to provide reasonable protection against harmful interference when the equipment is operated in a commercial environment. This equipment generates, uses and can radiate radio frequency energy and, if not installed and used in accordance with the instruction manual, may cause harmful interference to radio communications. Operation of this equipment in a residential area is likely to cause harmful interference in which case the user will be required to correct the interference at his own expense.</i></p>



Do not use the device under conditions other than those described in the technical characteristics

Risk of fire or explosion in case of improper use:

- Recharging of the battery
- Short circuiting of the battery

If the device is used in a manner not specified by the manufacturer, the protection provided by the device may be compromised.

II. INSTALLATION RECOMMENDATIONS

The LoRa® *TEMP'* is a temperature indicator communicating in radio frequency with software hosted on a web platform via the public LoRa® long distance network or via a private gateway. To ensure optimal radio transmission, a number of recommendations must be observed, since any wireless transmission is subject to interference

a) Sources of disturbances or attenuation

- The presence of obstacles in the wave path around the LoRa® *TEMP'* or between the LoRa® *TEMP'* and the Gateway (wall, furniture, people...) or near the antenna.
- The thickness of an obstacle in the wave path. The attenuation is greater diagonally than perpendicularly

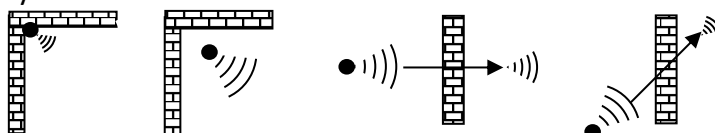

- A solid metal wall will not allow transmission by radio. A perforated metal wall will allow waves to pass while attenuating them.

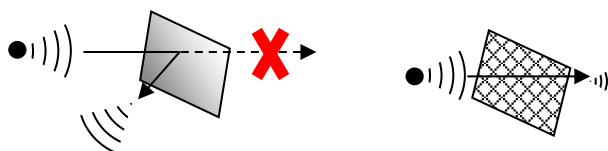

b) Positioning

- The LoRa® *TEMP'* can be placed inside or outside the monitored unit at a least 20 cm from the user or any nearby persons.
- For installations outside the monitored unit, put the device sufficiently high on the wall to avoid interference with obstacles and people passing by.
- The LoRa® *TEMP'* uses the LoRa® public network.
- Never place the LoRa® *TEMP'* horizontally.



To ensure your safety during installation or an intervention on a device placed in a high position, use proper equipment which is in good condition and provides adequate stability. Wear appropriate, non-slip shoes and install warning signs around the work area if the intervention takes place in a high traffic area.

III. PRESENTATION

a) Case

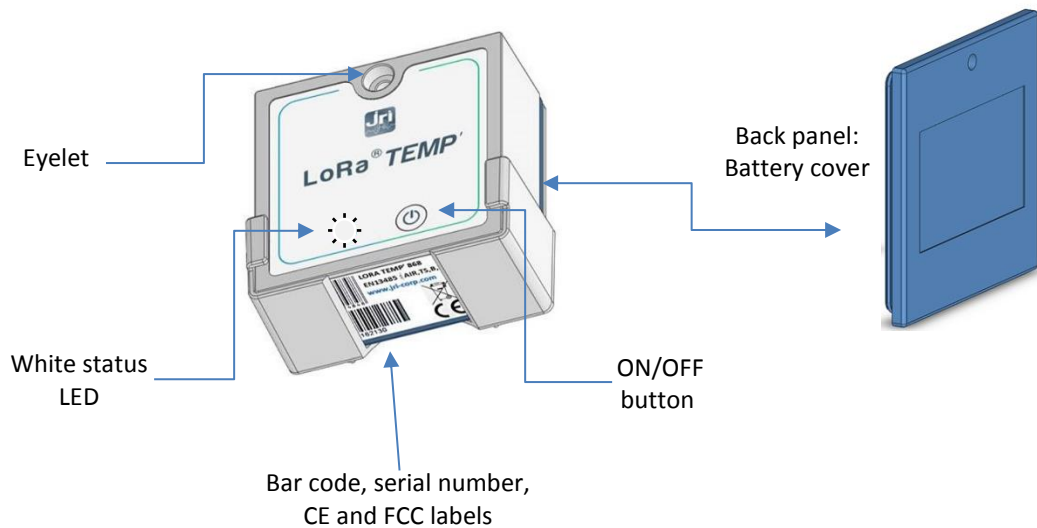

b) Mounting

The LoRa® TEMP' can be mounted in two different ways:

1 Via the eyelet:

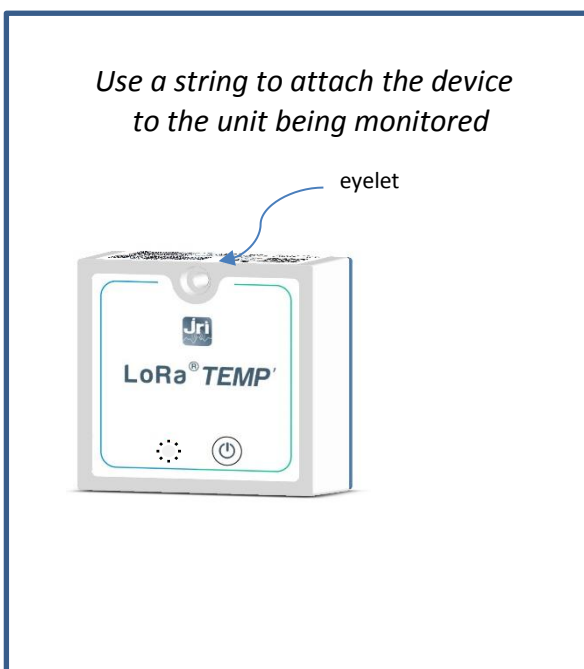

2 Via the supplied wall-mount bracket

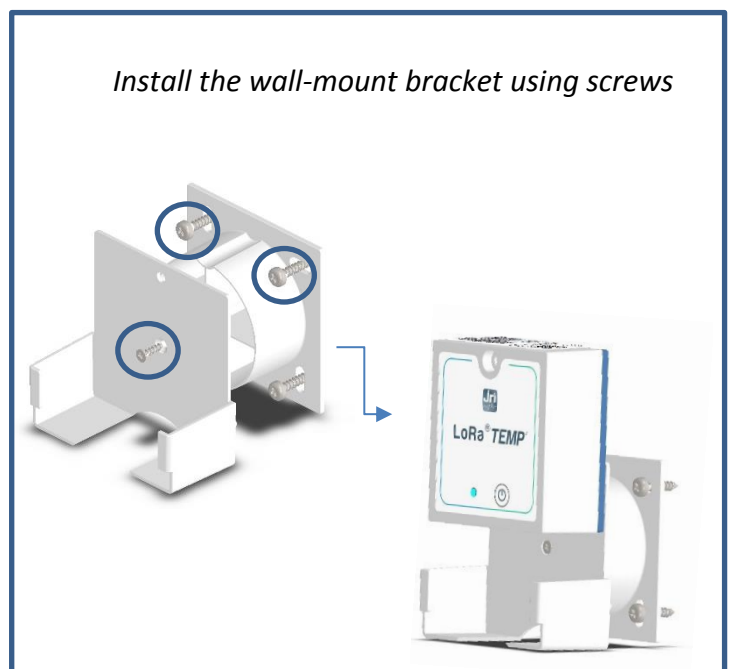

IV. USE

When you receive the LoRa® TEMP' it is turned off: it can neither send nor receive data.

a) Device activation



To activate the LoRa® TEMP' press and hold the On/Off button for more than 3 seconds. Once the device has been activated it starts measuring and transmitting data to MySirius at the set intervals.

Note: The LED lights up when the minimum press time is reached, allowing you to know when to release the On/Off button.

b) Turning off the device



To turn off the LoRa® TEMP', press and hold the On/Off button for approximately 3 to 6 seconds.

Note: a user configurable parameter on MySirius makes it possible to prevent an unwanted deactivation if the on/off button is pressed accidentally.

c) LED functionality

DEVICE STATUS	LED BEHAVIOUR
OFF	No light
ON (connected to MySirius)	1 fast blink (10ms) every 5 seconds
Stopping	Steady light on for 3 seconds when the action has been taken into account
Activation and connection with JRI MySirius in progress	1 fast blink every 1 second.
No network/gateway connection	No light (indicator off)
Technical default Threshold alarm	2 fast blinks (10 ms) every 5 seconds (the blinking stops when the problem has been corrected)
FSK mode (factory network)	1 slow blink (100 ms) every 5 sec.

V. BATTERY REPLACEMENT

a) Removal of the battery

- Lift the back panel off ①
- Remove the grid ②
- Take the battery ③ out of its compartment.

b) Installation of the new battery

- Insert the new battery ③ into the battery compartment and make sure that it is properly aligned.
 - Put the grid back ②
 - Put the back panel back ①
- Battery detection is confirmed by the activation of the LED for a couple of seconds. The device can be switched on when the LED stops flashing.

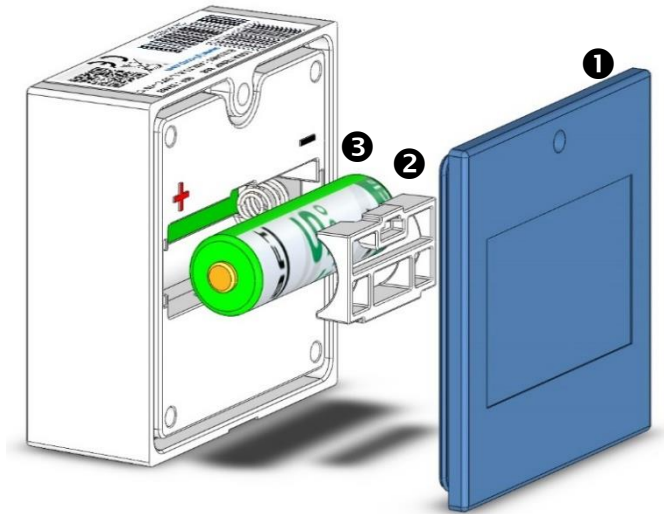

KEEP THE BATTERY AWAY FROM FIRE, DO NOT ATTEMPT TO RECHARGE OR SHORT CIRCUIT IT

- Recommended battery : LS14500 type AA 3.6V 2600 mAh or LS17500 3.6V 3600 mAh

VI. CHARACRERISTICS

LoRa® TEMP' - (internal probe)

HMI	: 1 white LED + 1 push button
Communication	: LoRa® 868MHz, 915MHz ou 470 MHz
Memory	: 100 time-stamped measurements
Sensor	: Internal CI A PT100 sensor
Operating range	: -30+70°C
Measurement range	: -30+70°C
Storage temperature	: -40+85°C
Accuracy	: ±0.5°C from 0°C to +25°C / ±1°C from -20°C to 0°C and from +25°C to +70°C / ±2°C from -30°C to -20°C
Resolution	: 0.01 °C
IP rating	: IP65 with condensation resistance
Shock rating	: IK05
Recording and transmission interval	: adjustable from 5 min to 24h
Measurement interval	: adjustable from 5 min to 24h
Response time	: ~ 10 min
Power Source	: Lithium battery type A (14 or 17 mm in diameter) - Battery life (⌀14 mm) : 5 years with the following uage profile: <ul style="list-style-type: none">• Fixed measurement interval : 10mn• Recording Interval: 120 mn• Transmission interval: 6 hours - Battery life (⌀17 mm) : 7 years with the following uage profile: <ul style="list-style-type: none">• Fixed measurement interval : 10mn• Recording Interval: 120 mn• Transmission interval: 6 hours
Case	: White ABS – Food contact safe
Dimensions	: 65 mm x 65 mm x 28 mm
Weight	: ~ 100 gr

a) Compliance

- CE Marking RED Directive 2014/53/EU
- Radio 868: EN300220-1 v3.1.1 : 2017
- SAFETY REQUIREMENTS FOR ELECTRICAL EQUIPMENT FOR MEASUREMENT, CONTROL, AND LABORATORY USE : EN61010-1 / 2010
- CEM: en301486-3 v2.1.1 / 2016
- FCC: 15C
- 470 Mhz : CCC
- Reach
- ROHS
- NF EN 13485 Classe 1
- Lora WAN Certification

VII. CLEANING

Clean the device with a soft, dry or slightly damp cloth. To remove stubborn stains, use a cloth soaked with a mild non-abrasive detergent solution, then wipe the surface with a soft, dry cloth.

Don't use benzene, thinners, alcohol or other types of solvents which might damage the finish.

VIII. GUARANTEE

Our products carry a one-year guarantee against manufacturing defects, malfunction, or abnormal wear. This guarantee does not cover damage caused by accidental misuse, incorrect use of the product, abnormal storage conditions, neglect in product use, or modification of hardware/software not carried out by JRI. This guarantee is limited to the sole replacement of the defective parts and the repair of the involved instruments, returned carriage paid to our factory, and excludes any damage or ancillary costs.

The guarantee starts from the date of the invoicing of the concerned product. For any guarantee application request, the purchase invoice should be produced. Under-guarantee repairs do not extend the guarantee limit granted at the sale of the product.

IX. MAINTENANCE CONTRACT

How best to optimize your radiofrequency installation?

Radiofrequency measurement systems communicate through Hertzian waves. Many factors (change in installation, moving, supplemental wall, interference with another radio system...) can nonetheless modify the radio pathway previously defined. The use of radiofrequency thus requires periodic monitoring by recognized specialists.

It is for this reason that JRI has developed for you the maintenance contract. We simplify your procedures by offering you a fully integrated solution. This global service offer includes both maintenance and metrological services, ensuring optimum function of your devices or of your installation.

You'll no longer have to worry about the maintenance of your devices!

This maintenance contract allows you to benefit, for a minimum period of 2 years, from a variety of services such as:

- annual or biannual verification of the material
- an extension of the guarantee
- telemaintenance
- telephone assistance **+33 (0) 892 680 933 (0,282 € /min)**
- replacement of the material onsite or by a return-to-factory
- verification of measurement accuracy (metrological certificate)
- battery replacement
- access to new software versions
- intervention within 48 working hours following the identification of the fault by our experts

X. ENVIRONMENTAL PROTECTION

JRI recommends to dispose unusable and/or irreparable measurement and recording materials in a manner compatible with the protection of the environment. As the production of waste materials cannot be avoided, these should be reused through the recycling process best adapted to the concerned materials and to the protection of the environment.

RoHS Directive

The RoHS European directive regulates and limits the presence of dangerous substances in electronic and electric equipments (EEE).

All new electronic equipments designed, developed and manufactured by JRI are in compliance with the aforementioned Directive 2002/95/CE.